

The logo features the word "Rose" in a red, elegant script font, with a small black rose and leaf icon integrated into the end of the word. Below it, the word "collection" is written in a bold, black, sans-serif font.

Rose
collection

Timber-alternative sash windows



Your home is important. You invest so much into it, creating a happy, safe and protective environment for you and your family. It is also likely to be your biggest investment, and so it too needs protecting.

The Rose Collection is a suite of three stunning sash windows, designed and manufactured in the UK by Roseview—the original timber-alternative sash window manufacturer. They blend the charm and appearance of classic timber with the benefits of modern manufacturing techniques and materials. The result is a collection of timeless stylish sash windows that keep your home secure, warm and quiet, all in a virtually maintenance-free package that never needs repainting.

First manufactured in 1985, each window in the Rose Collection has decades of experience and expertise built-in as standard. Rose Collection windows are precisely engineered using cutting-edge manufacturing technology, then expertly crafted and impeccably hand-finished.

The Rose Collection — sash windows designed for you and your home.

Traditional style and elegance. Modern performance. No compromises.

[#TraditionRedefined](#)

Contents

The Ultimate Rose	4	Designed for you	36
The Heritage Rose	14	Built by Roseview	38
The Charisma Rose	22	Conservation	39
Comparison of Models	30	Refurb and New Build	40
Colours & Finishes	32	Accreditations	41



QUITE SIMPLY, THE
UK'S MOST AUTHENTIC
TIMBER-ALTERNATIVE
SASH WINDOW



Ultimate
Rose



The Ultimate Rose



Ultimate Rose is the epitome of the Rose Collection design philosophy – outstanding aesthetics and exceptional performance. Ultimate Rose is, quite simply, the UK’s most authentic timber-alternative sash window. It redefines tradition.

We’ve re-engineered the timber-alternative sash window from the ground up, looking at every seam and detail that differed from a timber original and designing it out. The ultra-slim 35mm meeting rail, the seamless sash horns and even the internal sash interlock – everything has been redesigned to achieve what no other timber-alternative sash window can; a smooth, seamless finish. The result is that even from close up you won’t know that it’s not timber.

Based around our innovative true mechanical jointing system, Ultimate Rose is built in exactly the same way as timber. There are no mitred welds or false mechanical joints here, just simple, strong, joinery-style butt joints – horizontal on the frame and vertical on the sashes – just like a timber original.

The attention to detail matters.

But while Ultimate Rose may look identical to traditional timber sash windows, the one place it’s designed to be different is in performance. ‘A’-rated energy efficiency, high security and independently tested sound insulation mean that not only will your home look great with Ultimate Rose, it will be warm, quiet and secure.

Add all this together and you get a modern sash window that looks and performs better than anything else on the market.

That’s why we call it Ultimate Rose.

What makes Ultimate Rose special?



Ultimate Rose is, quite simply, the UK's most authentic timber-alternative sash window, designed and built by the UK's original specialist uPVC sash window manufacturer.

It has been designed and built around a range of features that are essential to achieving two goals: to offer the maintenance-free performance of a modern window, while retaining all the character and charm of a period sash window.

Some of those features we take for granted; deep bottom rails, run-through horns and traditionally styled window furniture. Others are unique to Ultimate Rose.

Standard features

The following features are fundamental to the original design of Ultimate Rose. They're included as standard—you don't have to pay extra to get full authenticity.

Seamless construction

It's not just what you add to a window to make it authentic, what you take away is just as important. Standard uPVC sash windows have caps and covers that create tell-tale seams and shadow lines. We've pioneered the development of seamless technology that removes these lines, leaving a smooth, continuous surface—just like timber.

Mechanical joints

All the joints on Ultimate Rose are genuine joinery-style mechanical butt joints—a fundamental part of a traditional sash window. Nothing is welded. And the orientation of the joints is exactly the same as timber—vertical on the sashes, horizontal on the frame.

35mm midrail

Look at an original sash window and you'll notice how slim the timbers are. Ultimate Rose matches these slim sightlines throughout, but nowhere more obvious than the midrail. We developed a special ultra-slim midrail that's only 35mm deep. It's the slimmest on the market; a full 10% slimmer than the nearest rival.

Paint-effect finish

Typically uPVC windows have either a smooth glossy finish or an applied woodgrain texture. But neither of these accurately match the effect of paint on timber. That's why we also offer Ultimate Rose in our unique chalk textured finish, for no extra cost. It removes the gloss of standard uPVC and adds texture without adding the false woodgrain that isn't there in real life.

Optional enhancements

There's no such thing as a one-size-fits-all sash window. Homes, and the windows in them, have their own styles. That's why we have a range of optional features that allow you to personalise Ultimate Rose to make it even more authentic to the style of you and your home.

Seahorse sash horn

Sash horns—or the lack of them—are an integral part of sash windows. Older windows from the Georgian period tended not to have them at all. Victorian windows used them to help strengthen the sashes, and from that point you'll see different designs, usually based on the area you're in or even the joiner who built the original windows.

As well as our usual seamless run-through horn, we've now developed a first for uPVC—a fully sculpted ornate sash horn like those used on the most expensive timber sashes. Why do we call it Seahorse? Look at the shape of the horn in profile!

Staff bead

On original timber windows the sashes were suspended from sash cords, literally hanging in position by the ropes alone. Therefore they required an internal bead to capture the bottom sash and prevent it from swinging inwards. This was the staff bead.

Not only is this not required on a modern window, it would get in the way of the sash tilting inwards for cleaning. However, we developed our removable staff bead to replicate this original detail while still allowing the sashes to tilt when required.

Deep cill

You'll often find thicker timbers used at the bottom of timber sash windows. When it rains this is where the water goes, so the timber at the bottom is more prone to rotting. This is why bottom sashes have deep bottom rails, and it's why we commissioned our optional deep cill. We don't have to worry about wood rot, but we do want to capture every detail of an original window. Deep cill is 50mm tall, instead of the usual 25mm.

Chamber cover

This feature has taken years of development to accomplish, and required a complete redesign of the sash gearing that makes the window operate.

On a timber window there's a smooth channel where the sashes slide. The sash weights were hidden behind this channel. Modern balanced sash windows can't do this, so there's a recess in that channel where the spring balances are located. This is called the balance chamber, and it's present on every modern sash window.

Chamber cover does exactly what it says—it covers the recess and gives a smooth finish, with just a narrow slot through which the sash is connected to the gearing.





Seamless run through horns

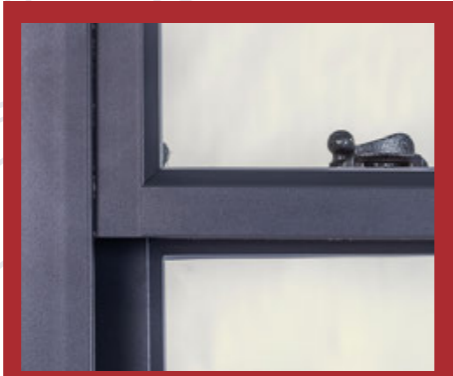

Seamless no horn option

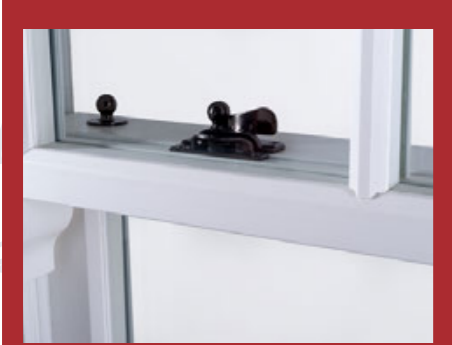

Seamless 35mm meeting rail

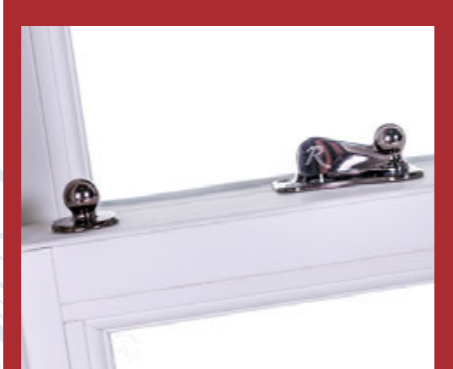

Traditional globe furniture



True mechanical joints



Authentic astragal bars



Optional deep cill



Optional staff bead



The Ultimate Rose



Benefits

- Maintenance-free – no more painting
- Widely specified in conservation areas
- Tilting sashes for simple cleaning

Features

- Closed-end true mechanical joints
- Ultra-slim 35mm seamless midrail
- Seamless run through sash horns
- Slim putty-line external profiles
- Deep bottom rail
- Aluminium-mounted authentic astragal bars
- Range of finishes and woodgrains
- Traditional globe furniture
(note: acorn furniture required for Part Q/PAS 24)

Optional Features

- Optional Seahorse sash horn
- Optional removable staff bead
- Optional external chamber covers
- Optional period deep cill

Options

Hardware Options

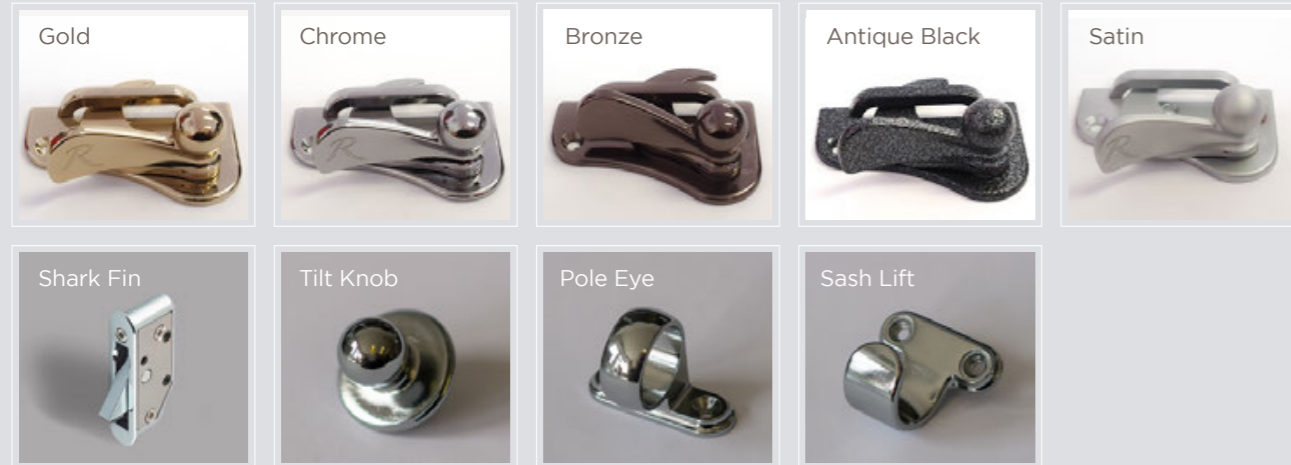

All available in: Gold, Chrome, Bronze, Antique Black, Satin, White
 Note: SBD / PAS24 requires acorn furniture

Vent Options

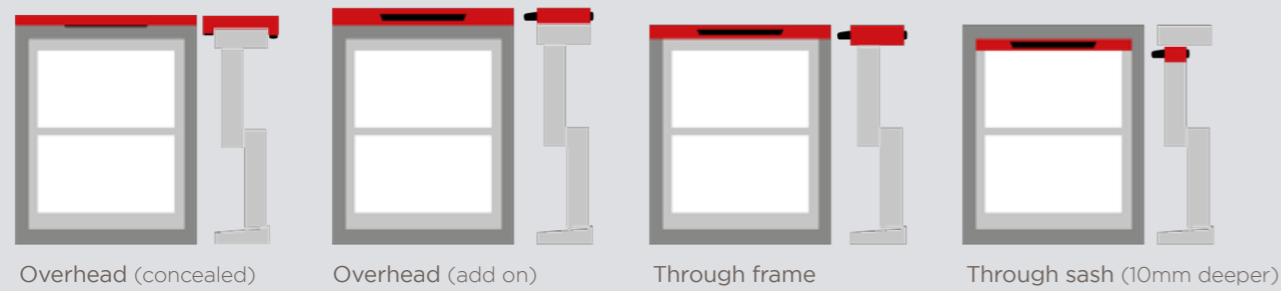

Horn Options



Chamber Cover

Staff Bead

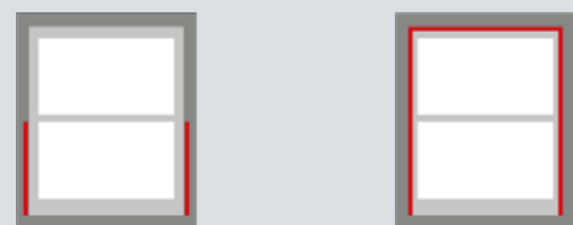

Cill Options

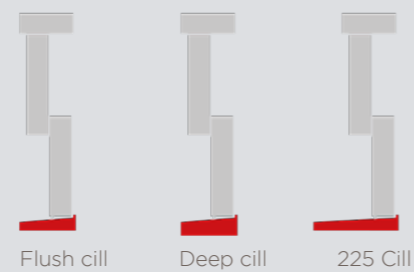

Ultimate
Rose

Technical Details

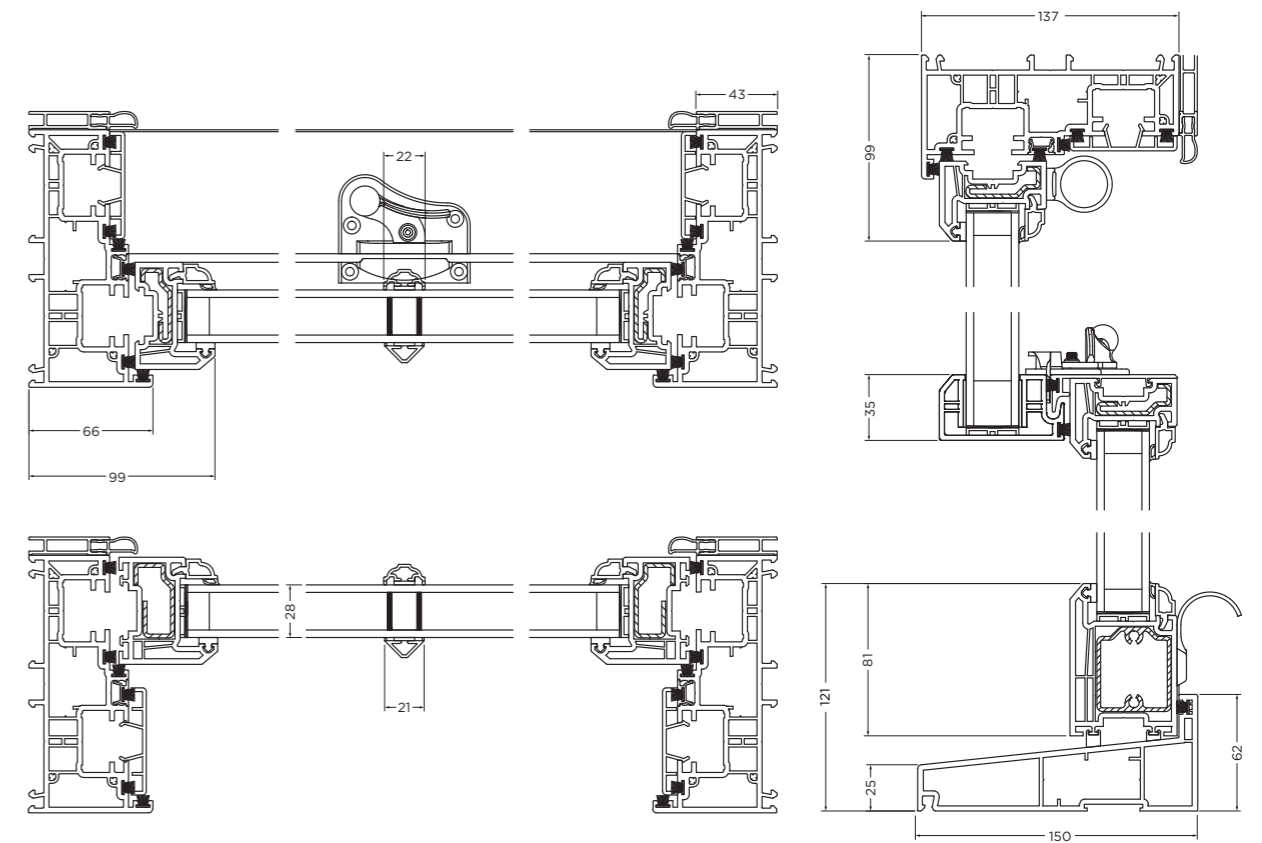

Icons with borders are standard features. Ones without borders are options.



THE QUINTESSENTIAL
PERIOD SASH WINDOW,
UPDATED FOR THE
21ST CENTURY



Heritage
Rose



The Heritage Rose



Tradition is the watchword of Heritage Rose

Second only to Ultimate Rose in terms of timber authenticity, Heritage Rose is a classically styled sash window that delivers the convenience and all-round excellence of modern uPVC.

Heritage Rose uses the same slim, putty-line profiles as Ultimate Rose, but with a wider 44mm midrail and welded joints. It also features optional flat run through horns, a deep bottom rail as standard and traditional chamfered astragal bars.

And while Ultimate Rose is indistinguishable from timber even from close up, the period detailing and profiles on Heritage Rose mean that from the pavement no-one will know that it isn't an original timber window.

Heritage Rose has been used in conservation areas across the UK, including the Royal Borough of Kensington and Chelsea, Cambridge, Lincoln, Snowdonia and the Lake District. Like every window in the Rose Collection it offers truly modern performance, keeping your home warm, quiet and secure.

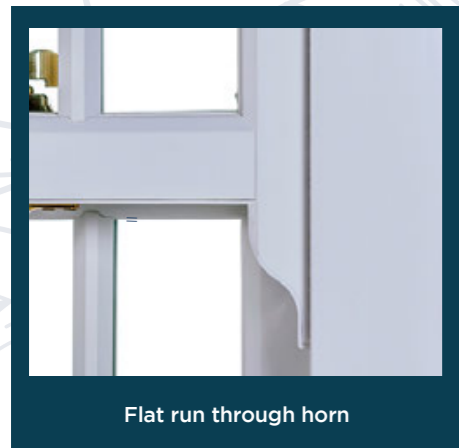

Flat run through horn



Mitre-welded corners

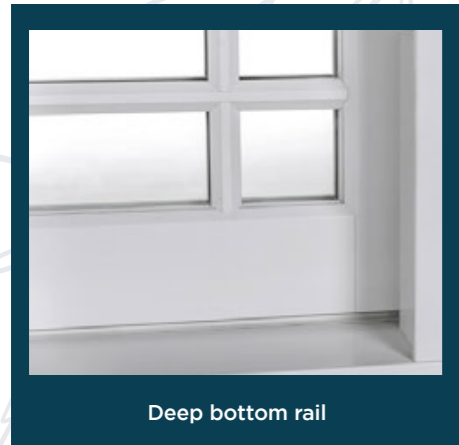

Deep bottom rail



Putty line chamfers



44mm midrail with flat interlock

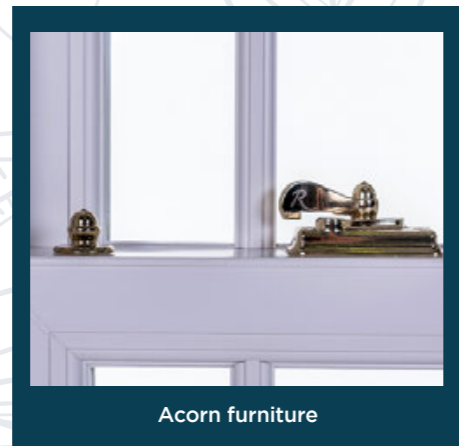

Acorn furniture



Heritage astragal bars



The Heritage Rose

Benefits

- Maintenance-free – no more painting
- Tilting sashes for simple cleaning

Features

- Welded joints
- Slim 44mm midrail
- Slim putty-line external profiles
- Deep bottom rail
- Aluminium-mounted heritage astragal bars in a range of period designs
- Range of finishes and woodgrains
- Classic acorn furniture

Optional Features

- Optional flat faced run through sash horns
- Optional flush or protruding cills

Options

Hardware Options



All available in: Gold, Chrome, Bronze, Antique Black, Satin, White

Vent Options

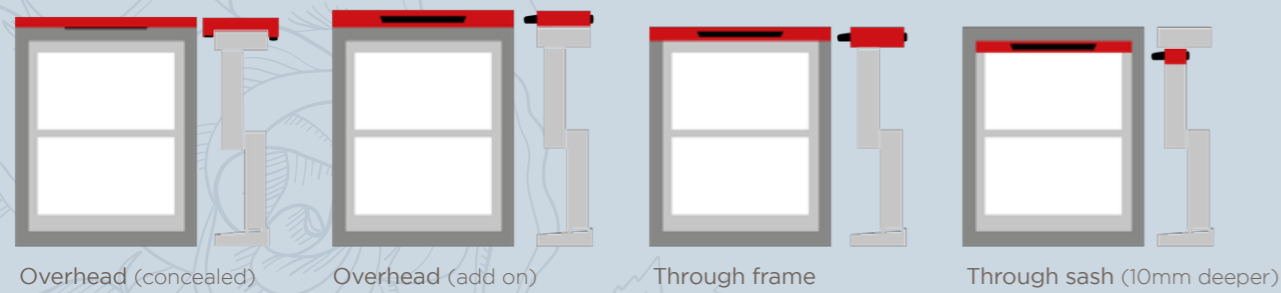

Horn Options

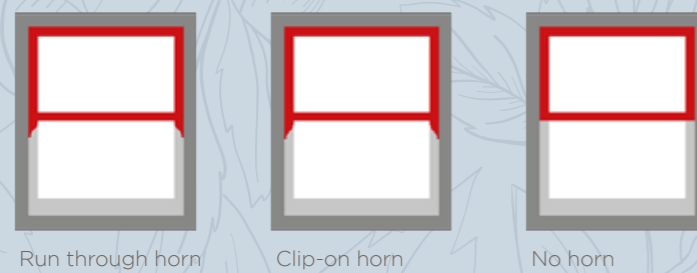

Cill Options

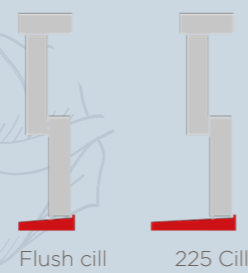

Heritage Rose

Technical Details

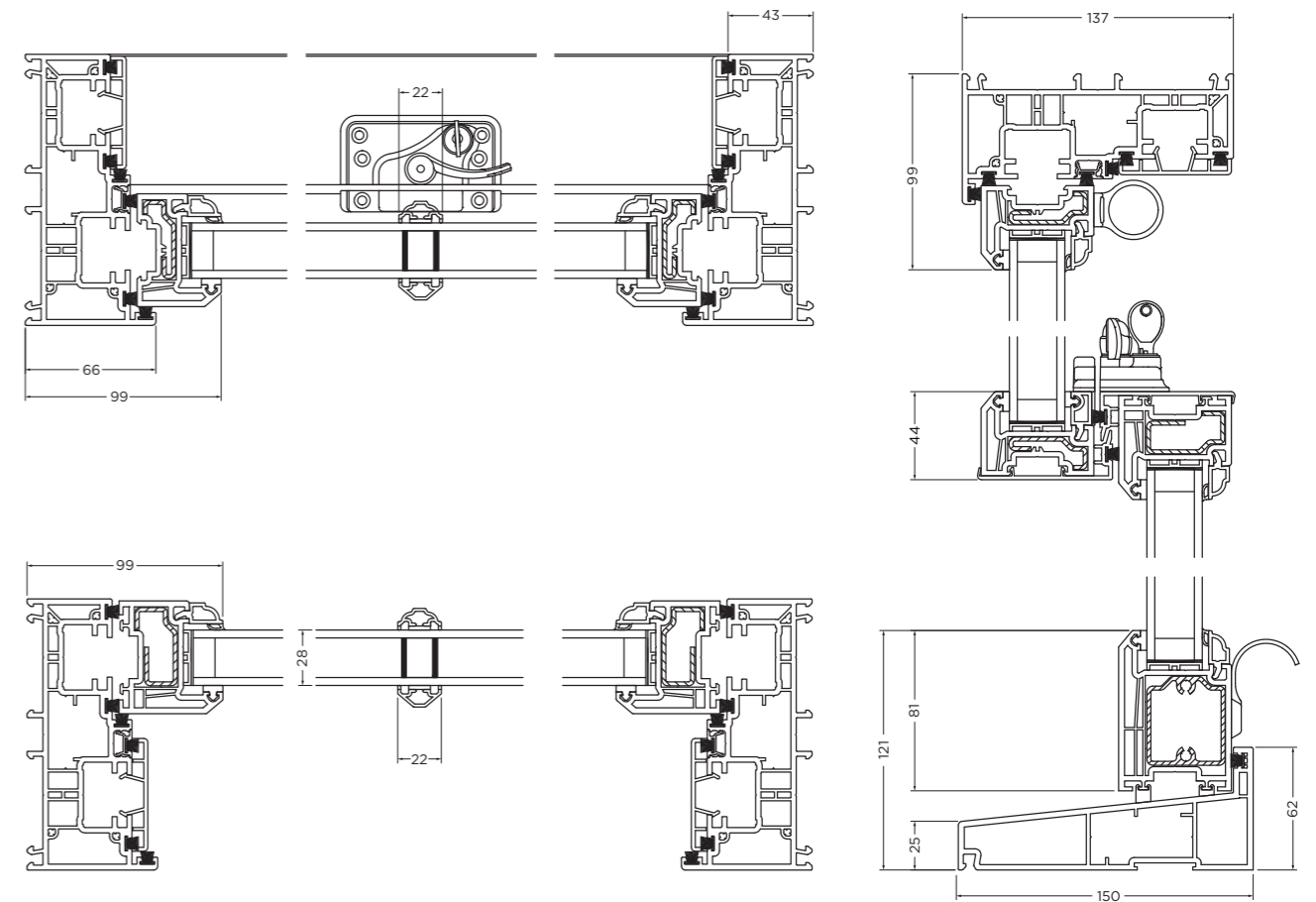

Icons with borders are standard features. Ones without borders are options.



COMPETITIVELY
PRICED PERIOD LOOKS
WITH A HOST OF
MODERN FEATURES



Charisma
Rose



The Charisma Rose



Contemporary, yet classic and uniquely versatile.

Take one of the most respected, competitively-priced uPVC systems on the market and turn it into a stylish timber-effect sash window – the result is Charisma Rose.

With a bolder, more contemporary appearance than its Rose Collection siblings, Charisma Rose is a versatile sash window ideally suited to everything from upgrading existing windows on older properties to adding retro-chic to newly built homes. And while it may be more budget-friendly than Ultimate and Heritage Rose, it's still built with the care, attention, and high quality components that are a hallmark of the Rose Collection.

Like all windows in the Rose Collection, Charisma Rose is low-maintenance, easy to operate and comes with a wide range of options and finishes. Competitively priced, it's a great all-rounder that offers contemporary yet classic style, with vintage details and modern performance.



60mm sculptured lines



No horn option

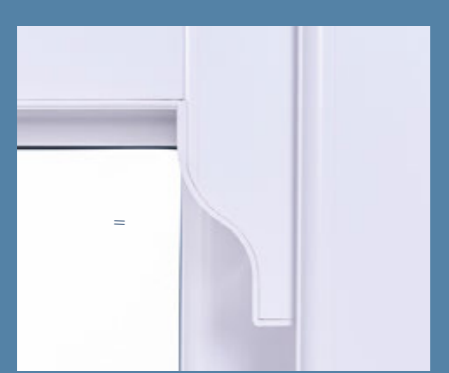

Run through horn option



Acorn furniture



Mitre-welded corners

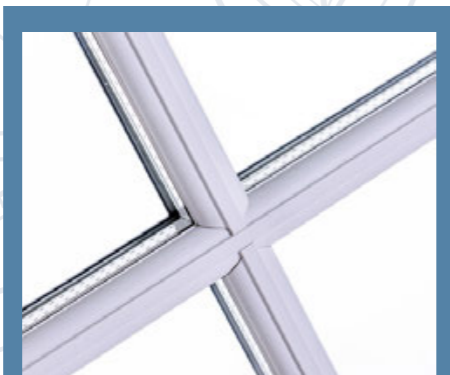

"Geo" astragal bars



The Charisma Rose

Benefits

- Maintenance-free - no more painting
- Tilting sashes for simple cleaning

Features

- Welded joints
- 60mm midrail
- Sculptured profiles
- Anti-jemmy bar
- Aluminium-mounted Geo astragal bars in a range of period designs
- Range of finishes and woodgrains
- Classic acorn furniture

Optional Features

- Optional flat faced run through sash horns
- Optional deep bottom rail



Options

Hardware Options

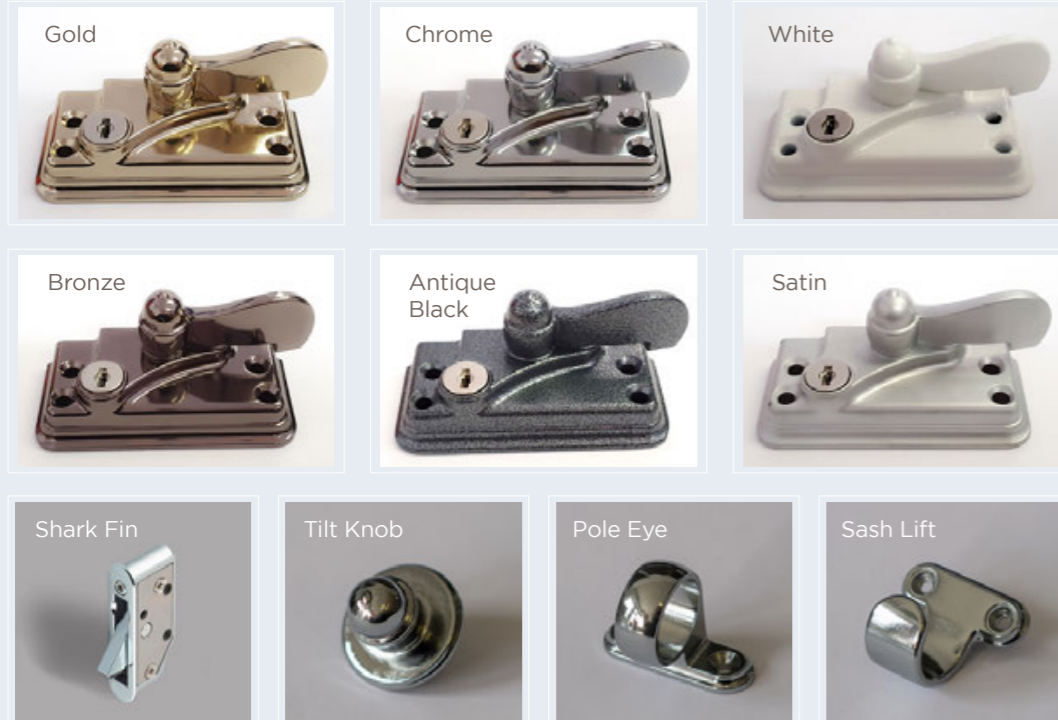

All available in: Gold, Chrome, Bronze, Antique Black, Satin, White

Vent Options

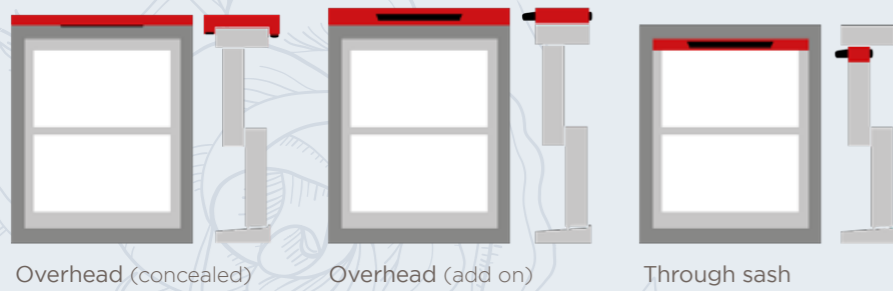

Horn Options

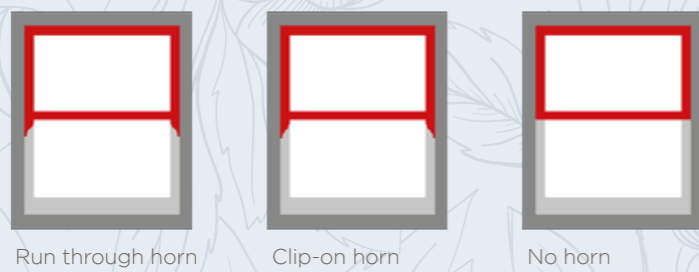

Cill Options

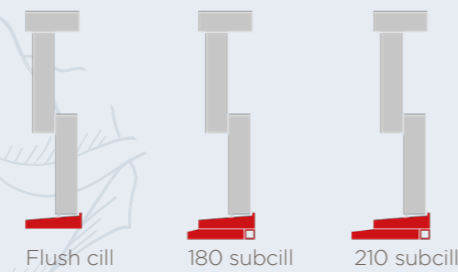

Charisma
Rose

Technical Details

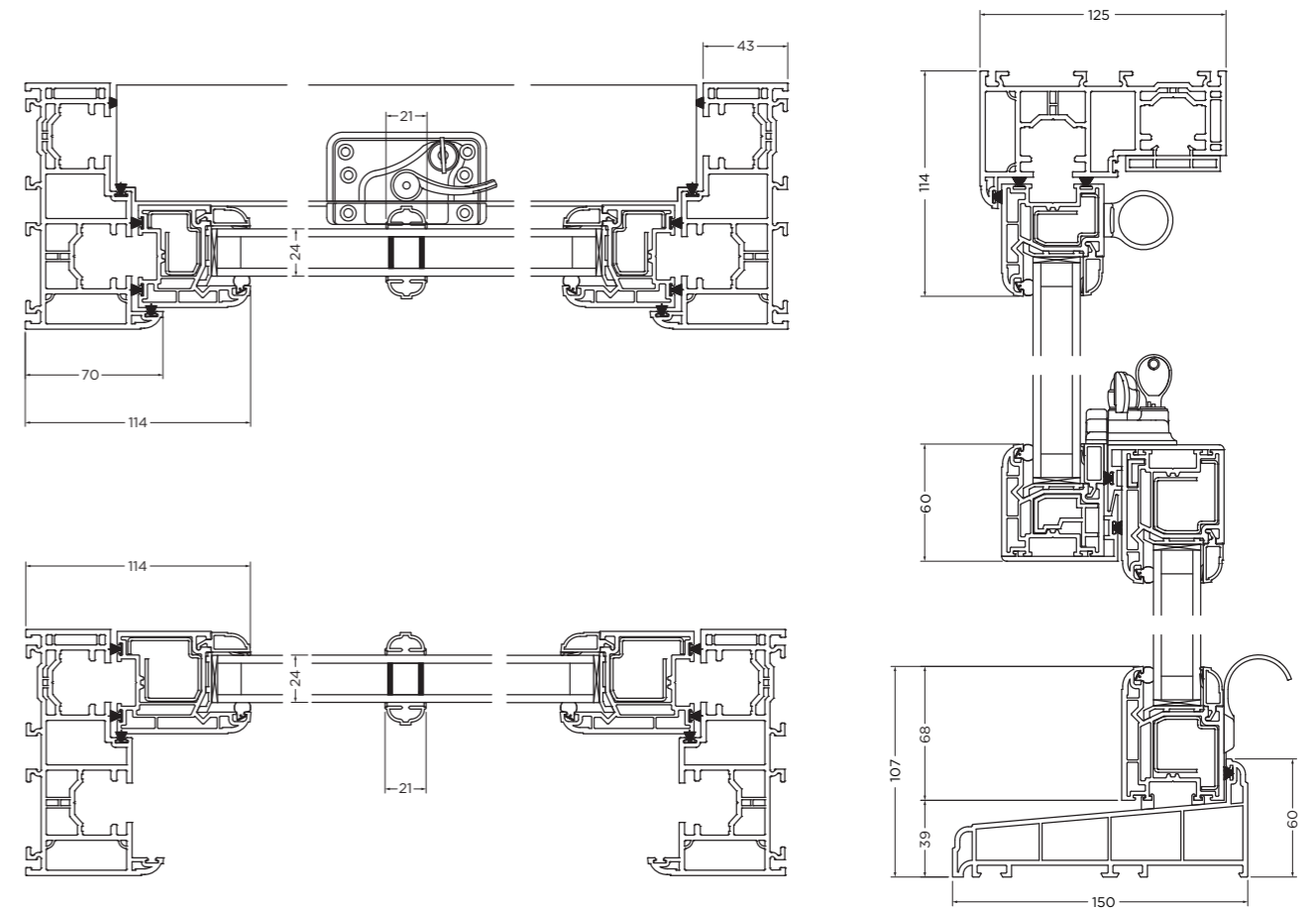

Icons with borders are standard features. Ones without borders are options.



Comparison of Models

The Rose Collection delivers unbeatable authenticity and exceptional performance. But as a range it's also hugely versatile, offering options that suit a diverse array of properties, budgets and applications.

The Collection consists of three core windows – Ultimate Rose, Heritage Rose and Charisma Rose. While each model has elements that make it unique, all three have some things in common:

- Available with or without sash horns
- 'A'-rated energy efficiency
- Upgradable acoustic protection
- Optional Secured by Design/ PAS24/Part Q security upgrade
- Available with arched or shaped heads
- Can be colour-bonded to any RAL colour on our range of foils
- Available in multi-part combinations and bays

The Ultimate Rose



- Profile detail:** putty line
- Meeting rail:** 35mm seamless
- Run through horn:** seamless
- Seahorse horn:** option
- No Horn:** seamless (option)
- Corner detail:** true mechanical
- Deep bottom rail:** standard
- Deep cill:** option
- Astragal bars:** authentic
- Furniture:** globe
- Removable staff bead:** option
- Chamber cover:** option
- Part Q/PAS24/SBD:** option

The Heritage Rose



- Profile detail:** putty line
- Meeting rail:** 44mm
- Run through horn:** flat (option)
- Seahorse horn:** not available
- No horn:** option
- Corner detail:** welded
- Deep bottom rail:** standard
- Deep cill:** not available
- Astragal bars:** heritage
- Furniture:** acorn
- Removable staff bead:** not available
- Chamber cover:** not available
- Part Q/PAS24/SBD:** option

The Charisma Rose



- Profile detail:** sculptured
- Meeting rail:** 60mm
- Run through horn:** flat (option)
- Seahorse horn:** not available
- No horn:** option
- Corner detail:** welded
- Deep bottom rail:** option
- Deep cill:** not available
- Astragal bars:** geo
- Furniture:** acorn
- Removable staff bead:** not available
- Chamber cover:** not available
- Part Q/PAS24/SBD:** option

Colours & Finishes

Enhance your windows with our range of colours & finishes

Choose from Smooth, Woodgrain or Chalk textured finishes

Ultimate Rose



Chalk finish only available for Ultimate Rose

Heritage Rose



Charisma Rose

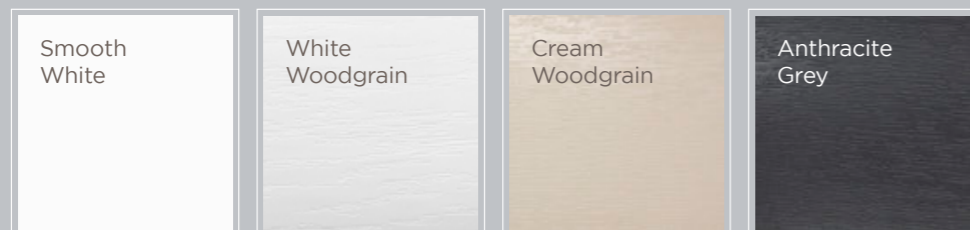

Popular colours

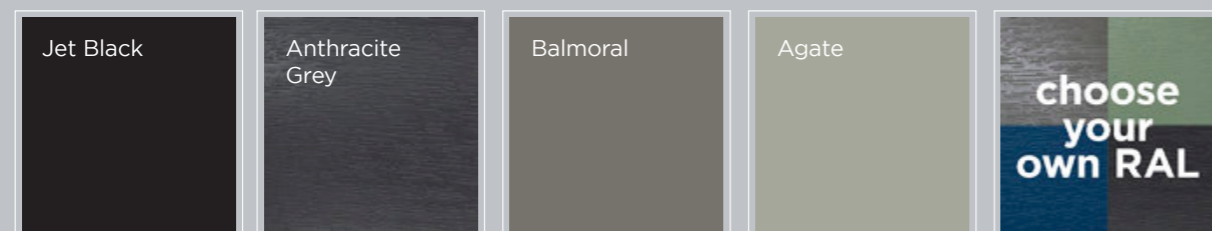

We can also supply your Rose collection windows in any RAL colour. Please ask for details.

Do I need trickle vents?

In 2022 significant changes were made to building regulations, including Approved Document F: Ventilation. Previously the rules on providing passive ventilation focused on new buildings. In 2022 that was changed to include existing buildings.

Before the change there was no requirement to add passive ventilation when replacing windows, as long as doing so didn't make the situation worse. In practice this meant that if the windows being replaced had trickle vents, the new ones needed them too.

Since June 2022 the regulations mean that you always have to ensure that there is a certain level of ventilation when replacing windows, even if the old windows had none. The level required is 8,000 mm² for each habitable room (including kitchens), with 4,000 mm² in bathrooms.

Effectively this means that all window replacement projects have to include trickle vents unless an alternative approved method is in place (e.g. mechanical ventilation), or the building is exempt. There are two key exemptions: conservation areas and buildings made from permeable building materials (such as lime mortar). For conservation areas, you need approval from the local conservation officer. Exemptions for permeable building materials are granted by the local building control officer.

In short, you should assume that trickle vents will be required unless you have an alternative in place or are using an exemption. We suggest talking to your installer and the relevant authorities to check the situation with them.

Trickle vent options

When trickle vents are required, we have a number of different ways of adding them to your windows.

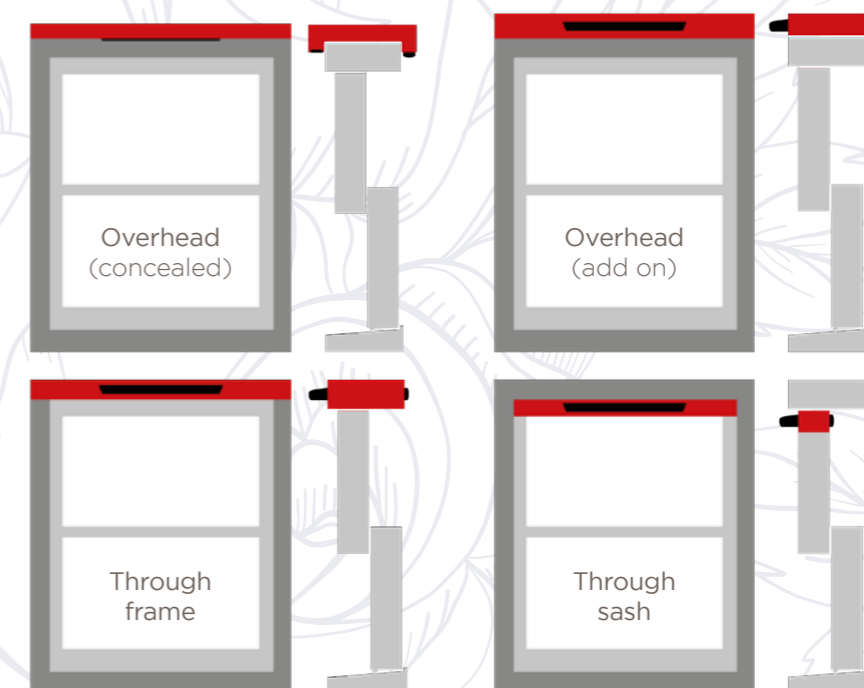



MORE THAN 30 YEARS
OF KNOWLEDGE,
EXPERIENCE & DESIGN
GOES INTO EVERY
SASH WINDOW
WE MAKE



Designed for you

Combine more than 30 years of sash window experience with industry-leading design, engineering and attention to detail, and you start to see why Rose Collection windows stand out from the crowd. The same amount of effort goes into every window we make, no matter which model you choose.

But more than that, we pride ourselves in doing everything we can to tailor our windows to your needs. No matter how complex or individual your specific requirements, if it's possible, we'll do it.

From curved and gothic arches to bespoke astragal bar and glass designs, there isn't much we haven't seen before. The features shown on this page are just some of the ways in which we can help make your vision a reality.



Bays, Astragal bars & Arches

When it comes to bays, bars and arches we can create a variety of custom designs to suit your needs. With our help, you can achieve any bay configuration you require - from squared to flared - with a combination of sash windows.

If you're looking for a traditional appearance without multiple window panes then astragal bars are the way to complete a truly authentic look. Roseview can create your windows to any specification to suit the style you want to achieve, whether that be Victorian, Edwardian or Georgian.

Although most sash windows are rectangular, arched and shaped heads are more popular than you may think. From gentle curves and fully semi-circular true arches, to pointed gothic arches and straight angled heads, we can manufacture your sash windows to virtually any shape you require.

Built by Roseview



Rose Collection sash windows effortlessly combine high-quality modern performance with detailed vintage aesthetics, using durable, long-lasting, maintenance-free modern materials. Manufacturing windows this way requires a complex mix of traditional craftsmanship and cutting-edge modern technology, brought together by years of experience and knowledge.

More often than not, standard uPVC windows are manufactured in large factories filled with more equipment than staff. Windows are made in a matter of hours, with very little human participation. Our Buckinghamshire manufacturing facility couldn't be more different.

Our factories has two distinct zones. The first is where cutting and milling takes place. This is precision work that requires state-of-the-art machinery to ensure accuracy and consistency. This is where you'll find our multi-million pound machining centres and CNC millers. The second is where we assemble, glaze and finish our windows. These are skilled tasks performed by our highly-trained workforce, making this part of the factory more like a large joinery than a typical window factory.

Our skilled, experienced staff do everything by hand, from completing the mechanical butt joints to glazing and applying astragal bars. Instead of taking mere hours, windows spend a week in our factory, from saw to door.

It's this combination of state-of-the-art technology, skilled traditional craftsmanship and years of experience that allows us to do what we do—we can't do it any other way.



uPVC in Conservation Areas



Sash windows are quintessentially British; they've been an important part of our architectural heritage since the 17th century. Unfortunately, many original sash windows have already been lost; replaced with inappropriate low-cost casements that aren't sensitive to their surroundings.

In response, more and more parts of the UK are being designated as conservation areas, sometimes with the extra protection of an Article 4 Directive. This helps to preserve the character and appearance of an area, and in doing so protect our architectural heritage.

Rose Collection sash windows have heritage and conservation at the heart of their design. In an area where sash windows are common, the Rose Collection blends in perfectly—a far superior option than the “mock sash” casement windows used so often in the past.

As you move up the model range, you move up in terms of authenticity. At the top you have Ultimate Rose—a window that looks and feels exactly like an original timber sash window, even from close up. In fact they're so authentic, we often receive comments from customers who say that people don't know they've replaced their windows. That's why Rose Collection sash windows have been approved for use on projects in conservation areas across the UK.

You should always check with your local authority to see if your project requires permission. Your local Rose Collection Approved Installer can help guide you through this process.

Refurb and New Build

While Rose Collection sash windows are an obvious choice for refurbishment projects, they're also popular in new builds. And while the windows used for each project type are the same, the requirements of those projects differ widely.

Typically sash windows are used in three scenarios: refurbishments where original sash windows are being replaced, refurbishments where sashes have previously been replaced with something less appropriate, and new buildings built in a classic style.

On refurbishment projects replacement windows have to be authentic, while offering improved performance over the windows they are replacing. Aesthetics are critical; whether it's a period property in a conservation area or simply a traditional home that was built for sash windows. Once the look and feel are right, the low-maintenance energy efficiency, security and acoustic benefits are a welcome bonus.

On new builds priorities are a little different.

Certification is key as regulations are much tighter than on replacement windows. Energy efficiency, security, ventilation, safety – these are all areas that need to pass stringent building regulations. Windows still need to look great, but they don't necessarily have to provide a perfect match to windows in older homes. Instead, they need to realise the vision of the architect or self-builder while fully complying with building regulations.

We've designed Rose Collection sash windows to work equally well in both refurbishment and new build projects. They have the classic style, slim sightlines and period detailing demanded by authentic refurbishments, while offering the full spectrum of modern performance benefits – backed up by independently tested certification – that modern building regulations require.

Accreditations

Rose Collection sash windows aren't just about authenticity and style; they also provide all the benefits you'd expect from cutting-edge design and modern materials and manufacturing techniques. So whether you're replacing old windows or building in new ones, you can be confident that your sash windows will offer both the performance and compliance that you need.



Energy Efficiency

All our windows are 'A' rated as standard, with a U-value of 1.5 W/m²K. With different glazing this can be further enhanced where required.

Weatherproofing

Rose Collection sash windows are independently tested to BS6375 for air and water permeability and wind loading. All models achieve Class 3 for air permeability, up to 8A – the highest you can get – for water tightness, and 1600 Pa (114.3 mph) for wind loading, which is classed as hurricane level.

Part Q/PAS 24

All Rose Collection sash windows are optionally available with the enhanced security that provides PAS 24:2016 accreditation and Part Q compliance for new builds.

Sustainability

uPVC is fully recyclable up to ten times, giving it a 350 year lifespan. Moreover, this is closed-loop recycling – new windows made from old.

Secured by Design

Building on our PAS 24:2016 format, all Rose Collection sash windows are available with Secured by Design accreditation.

Glass and Glazing Federation

Roseview are a proud and active member of the GGF. The GGF is recognised by the UK government and plays a key role in researching and defining new regulations (including Building Regulations) relating to windows, doors and glazing.

Acoustic testing

All models in the Rose Collection have been independently tested and audited. This makes them the only uPVC sash windows on the market with dedicated acoustic accreditation.



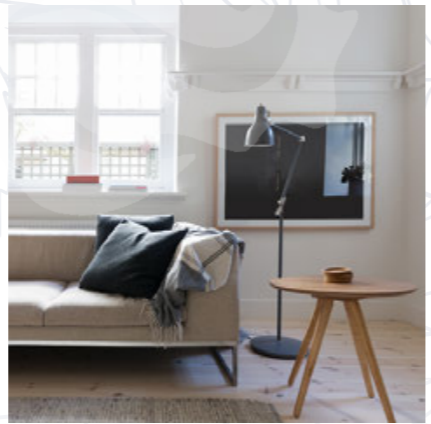
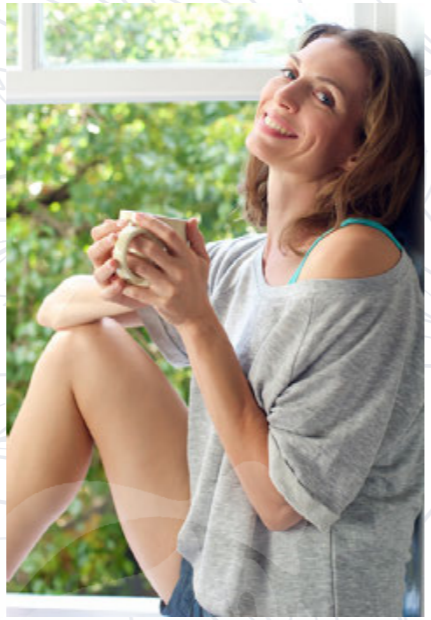

The Rose Collection

Rose collection

Ultimate rose

Heritage rose

Charisma rose

Incarnation secondary glazing

05/23. The content of this document, photographic reproduction and technical details remain the sole property of Roseview Windows, all rights reserved. It cannot be reproduced, in whole or in part, without explicit permission. Terms and conditions of sale apply, a copy of which is available on request.



